

At Sony we are constantly rethinking and redesigning in order to create innovative digital entertainment products. And we are also constantly rethinking and re-evaluating our products, processes and our potential impact on the planet. Thanks to our results in that direction, this product achieved the European Eco label award issued by the European Commission. You can get more information in following link: <http://ec.europa.eu/environment/ecolabel/>

Sony gives a minimum of 2 years guarantee for this LCD TV and 7 years availability for replacement of electronic parts.



For useful information about Sony products

<http://www.sony-europe.com/myproduct/>

<http://www.sony.net/>

© 2010 Sony Corporation

4-168-148-E2(1)

SONY®

LCD Digital Colour TV

Operating Instructions

Start-up Guide

Instruction Manual

Additional Information

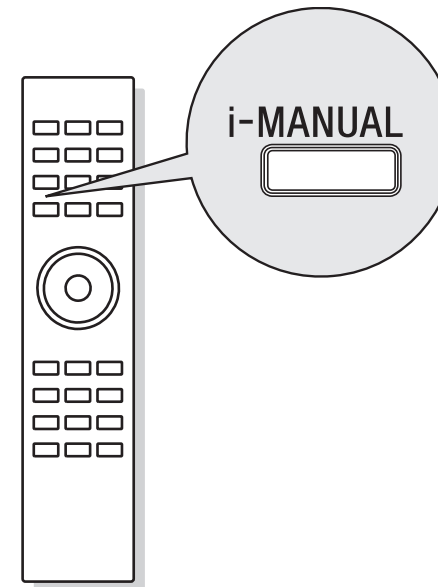

BRAVIA

KDL-46EX4xx / KDL-40BX4xx / KDL-40EX4xx / KDL-40NX5xx /
KDL-37EX4xx / KDL-32BX3xx / KDL-32BX4xx / KDL-32EX3xx /
KDL-32EX4xx / KDL-32NX5xx / KDL-26EX3xx / KDL-22EX3xx

Introduction

Thank you for choosing this Sony product.
Before operating the TV, please read this manual thoroughly and retain it for future reference.

Notice for Digital TV function

- Any functions related to Digital TV (**DVB**) will only work in countries or areas where DVB-T (MPEG-2 and H.264/MPEG-4 AVC) digital terrestrial signals are broadcast or where you have access to a compatible DVB-C (MPEG-2 and H.264/MPEG-4 AVC) cable service. Please confirm with your local dealer if you can receive a DVB-T signal where you live or ask your cable provider if their DVB-C cable service is suitable for integrated operation with this TV.
- Your cable provider may charge a fee for their services, or require you to agree to its terms and conditions of business.
- This TV set complies with DVB-T and DVB-C specifications, but compatibility with future DVB-T digital terrestrial and DVB-C digital cable broadcasts are not guaranteed.
- Some Digital TV functions may not be available in some countries/areas and DVB-C cable may not operate correctly with some providers.

For a list of compatible cable providers, refer to the support web site:

<http://support.sony-europe.com/TV/DVBC/>

The manufacturer of this product is Sony Corporation, 1-7-1 Konan Minato-ku Tokyo, 108-0075 Japan. The Authorized Representative for EMC and product safety is Sony Deutschland GmbH, Hedelfinger Strasse 61, 70327 Stuttgart, Germany. For any service or guarantee matters please refer to the addresses given in separate service or guarantee documents.

Trademark information

- **DVB** is a registered trademark of the DVB Project
- HDMI, the HDMI logo and High-Definition Multimedia Interface are trademarks or registered trademarks of HDMI Licensing LLC.
- Manufactured under license from Dolby Laboratories. Dolby and the double-D symbol are trademarks of Dolby Laboratories.
- ABOUT DIVX VIDEO: DivX® is a digital video format created by DivX, Inc. This is an official DivX Certified device that plays DivX video. Visit www.divx.com for more information and software tools to convert your files into DivX video.
ABOUT DIVX VIDEO-ON-DEMAND: This DivX Certified® device must be registered in order to play DivX Video-on-Demand (VOD) content. To generate the registration code, locate the DivX VOD section in the device setup menu. Go to vod.divx.com with this code to complete the registration process and learn more about DivX VOD.



About the model name in this manual

The “xx” that appears on the model name, corresponds to two numeric digits related to design or colour variation.



- The illustrations used in this manual are of the KDL-32EX402 unless otherwise stated.

Table of Contents

Start-up Guide

4

Safety information.....	9
Precautions.....	10
Instruction Manual	11
Overview of the remote	12
Overview of the TV buttons and indicators	14

Watching TV

Watching TV	15
Using the Digital Electronic Programme Guide (EPG) DVB	17
Using the Digital Favourite list DVB	18

Using Optional Equipment

Connecting optional equipment	19
Viewing pictures from connected equipment	20
Playing Back Photo/Music/Video via USB	21
Using BRAVIA Sync with Control for HDMI.....	22

Using MENU Functions

Navigating through TV Home Menu on XMB™	23
Settings	24

Additional Information

Installing the Accessories (Wall-Mount Bracket).....	33
Specifications.....	36
Troubleshooting.....	39

DVB : for digital channels only

- Before operating the TV, please read "Safety Information" 9. Retain this manual for future reference.
- Full operating instructions can be found on the screen.
- Instructions about "Installing Wall Mount Bracket" are included within this TV's instructions manual.

1: Checking the accessories

- Mains lead (1) (only for KDL-46EX4xx)
 - Cable holder (1) (only for KDL-40/32NX5xx)
 - Stand (1)*
 - Screws for stand (4) (only for KDL-46EX4xx)
 - Screws for stand (4 + 3) (only for KDL-40BX4/EX4xx, KDL-37EX4xx, KDL-32BX3/BX4/EX3/EX4xx, KDL-26EX3xx, KDL-22EX3xx)
 - Screws for stand (4 + 4) (only for KDL-40/32NX5xx)
 - Remote RM-ED022 (1)
 - Size AAA batteries (2)
- * Disassembled except for KDL-46EX4xx.

To insert batteries into the remote

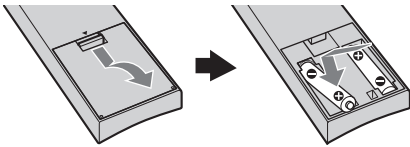



- Observe the correct polarity when inserting batteries.
- Do not use different types of batteries together or mix old and new batteries.
- Dispose of batteries in an environmentally friendly way. Certain regions may regulate disposal of batteries. Please consult your local authority.
- Handle the remote with care. Do not drop or step on it, or spill liquid of any kind onto it.
- Do not place the remote in a location near a heat source, a place subject to direct sunlight, or a damp room.

2: Attaching the stand

Follow the assembling steps required to place on a TV stand.

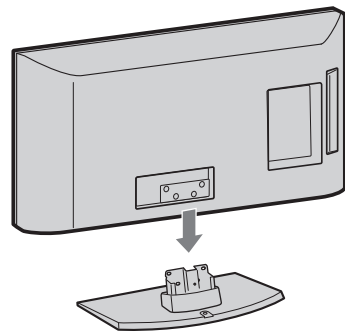
- 1 Refer to the supplied Table-Top Stand leaflet for proper attachment for some TV models.
- 2 Place the TV set on the stand. Take care not to interfere with cables.



- 3 Fix the TV to the stand according to the arrow marks  that guide the screw holes using the supplied screws.

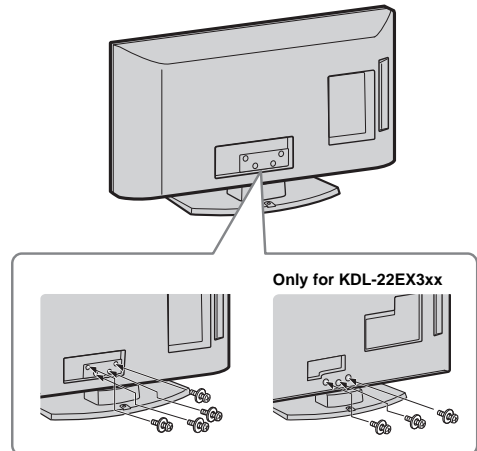

- If using an electric screwdriver, set the tightening torque at approximately 1.5 N·m (15 kgf·cm).

3: Connecting an aerial/cable/VCR/DVD recorder

Connecting an aerial/cable only

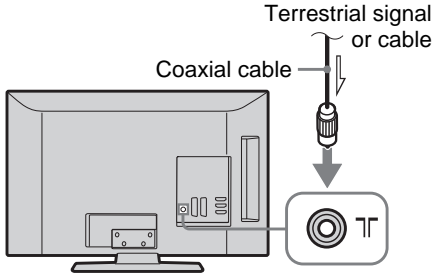

Connecting an aerial/cable/VCR/DVD recorder with SCART

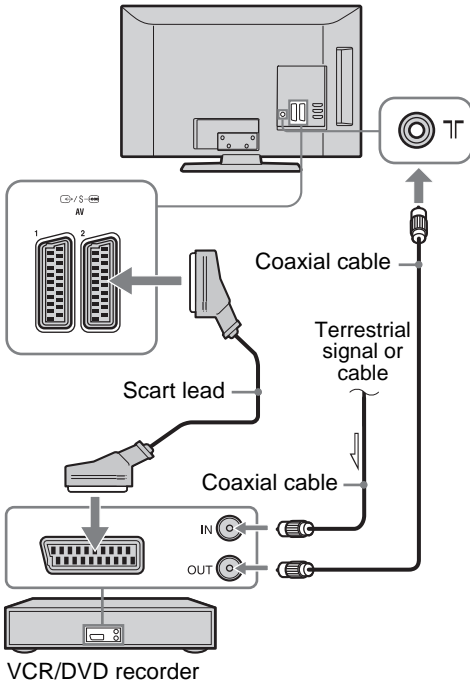

- AV1 outputs available only for analogue TV.
- AV2 outputs to the current screen (except PC, HDMI, Component, USB).

Connecting an aerial/cable/VCR/DVD recorder with HDMI

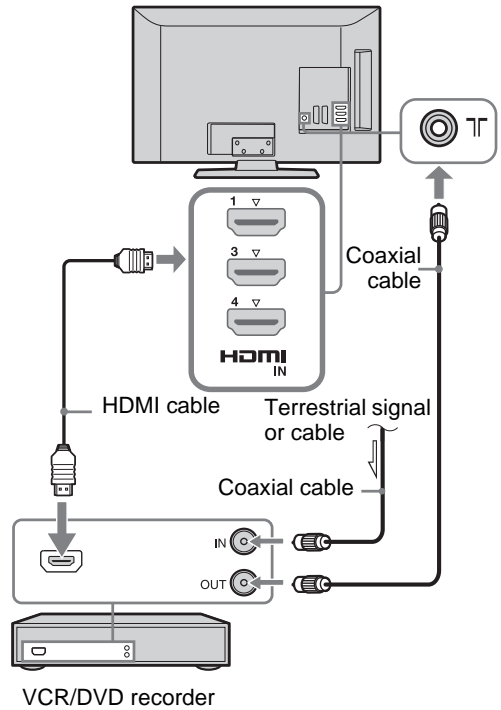

4: Preventing the TV from toppling over

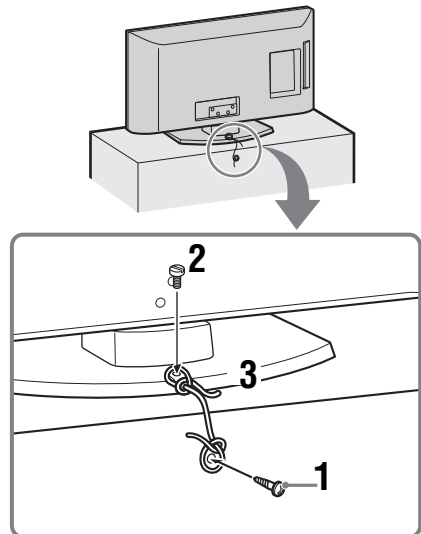

- 1 Install a wood screw (4 mm in diameter, not supplied) in the TV stand.

Continued

- 2 Install a machine screw (M4 × 16, not supplied) into the screw hole of the TV.
- 3 Tie the wood screw and the machine screw with a strong cord.



- An optional Sony support belt kit is used to secure the TV. Contact your nearest Sony Service Centre to purchase a kit. Have your TV model name ready for reference.

5: Bundling the cables

(only for KDL-40/32NX5xx)

You can bundle the connecting cables as illustrated below.

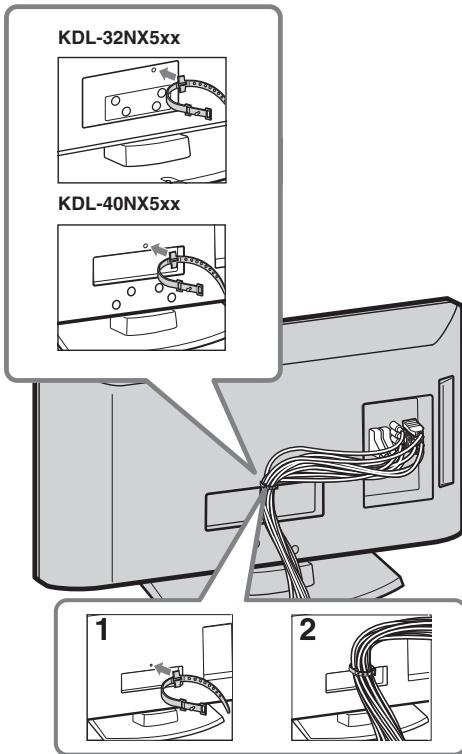

- Do not bundle the mains lead with other connecting cables.

6: Selecting the language, country/region and location

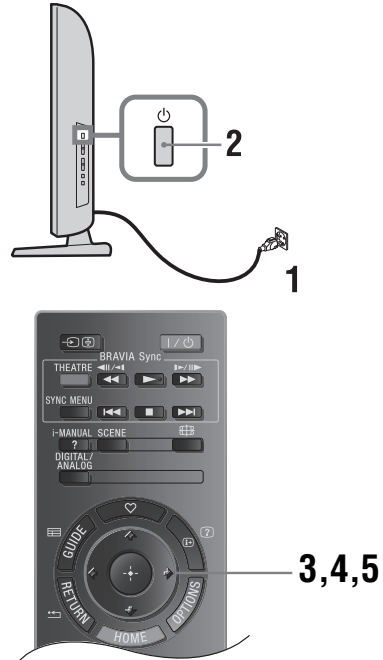

- 1 Connect the TV to your mains socket (220-240V AC, 50Hz).
- 2 Press on the side of the TV. When you turn on the TV for the first time, the Language menu appears on the screen.
 - When you turn on the TV, the power indicator light up in green.
- 3 Press / to select the language displayed on the menu screens, then press .

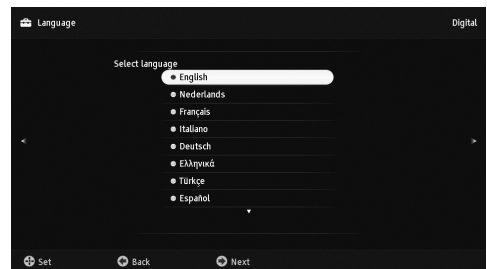

- 4 Press \uparrow/\downarrow to select the country/region in which you will operate the TV, then press \oplus .



If the country/region which you want to use on the TV does not appear in the list, select “-” instead of a country/region.

- 5 Press \uparrow/\downarrow to select the location type in which you will operate the TV, then press \oplus .

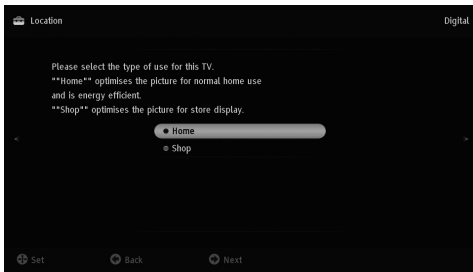

In Shop mode, some settings will be periodically reset for Shop usage.

This option selects the initial picture mode appropriate for the typical lighting condition in these environments.

7: Auto-tuning the TV

- 1 Press \oplus .

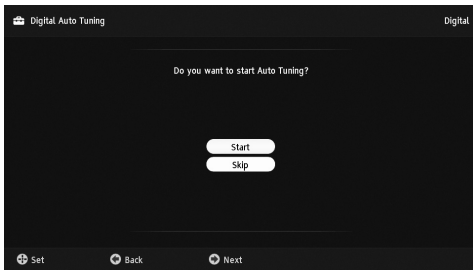

- 2 Press \uparrow/\downarrow to select “Antenna” or “Cable”, then press \oplus .

If you select “Cable”, the screen for selecting the scan type appears. See “To tune the TV for Cable connection” (page 7).

The TV starts searching for all available digital channels, followed by all available analogue channels. This may take some time, so do not press any buttons on the TV or remote while proceeding.

If a message appears for you to confirm the aerial connection

No digital or analogue channels were found. Check all the aerial/cable connections and press \oplus to start auto-tuning again.

- 3 Programme Sorting (Only in analogue mode): Changes the order in which the analogue channels are stored on the TV.

1 Press \uparrow/\downarrow to select the channel you want to move to a new position, then press \rightleftarrows .

2 Press \uparrow/\downarrow to select the new position for your channel, then press \oplus .

If you do not change the order in which the analogue channels are stored on the TV, press HOME to go to next step.



- This step will not appear if any analogue channel is found.

The message "Set-up complete" will appear on the screen. Press \oplus .

The TV has now tuned in all the available channels.

To tune the TV for Cable connection

- 1 Press \oplus .

- 2 Press \uparrow/\downarrow to select “Quick Scan” or “Full Scan”, then press \oplus .

“Quick Scan”: channels are tuned according to the cable operator information within the broadcast signal.

Recommended setting for "Frequency" and "Network ID" is "Auto".

This option is recommended for fast tuning when supported by your cable operator.

If the "Quick Scan" does not tune, please use the "Full Scan" method below.

“Full Scan”: All available channels are tuned and stored. This procedure may take some time.

This option is recommended when "Quick Scan" is not supported by your cable provider.

For further information about supported cable providers, refer to support web site:

<http://support.sony-europe.com/TV/DVBC>

- 3 Press $\leftarrow/\rightarrow/\downarrow$ to select “Start”.

The TV starts searching for channels. Do not press any buttons on the TV or remote.



- Some cable providers do not support “Quick Scan”. If no channels are detected using “Quick Scan”, perform “Full Scan”.

Adjusting the viewing angle of the TV

This TV can be adjusted within the angles shown below.

(only for KDL-40/32NX5xx)

Adjust the angle left and right (swivel)

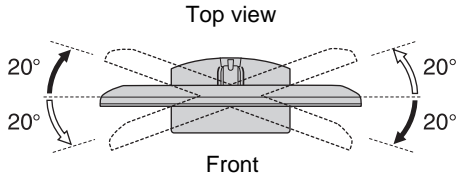

(only for KDL-22EX3xx)

Adjust the tilt

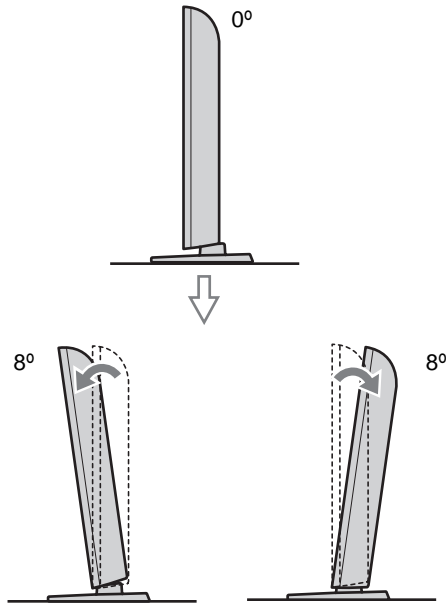

Detaching the Table-Top Stand from the TV



- Do not remove the Table-Top Stand for any reason other than to wall-mount the TV.

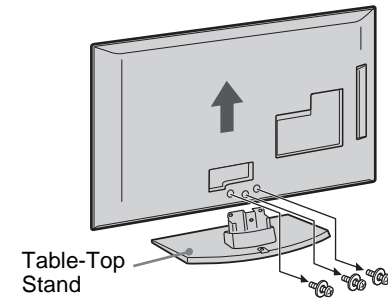
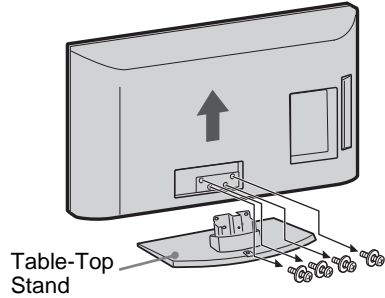

(only for KDL-22EX3xx)

Safety Information

Installation/Set-up

Install and use the TV set in accordance with the instructions below in order to avoid any risk of fire, electrical shock or damage and/or injuries.

Installation

- The TV set should be installed near an easily accessible mains socket.
- Place the TV set on a stable, level surface.
- Only qualified service personnel should carry out wall installations.
- For safety reasons, it is strongly recommended that you use Sony accessories, including:
 - Wall-mount bracket SU-WL500 (KDL-46EX4xx, KDL-40BX4/EX4/NX5xx, KDL-37EX4xx, KDL-32BX3/BX4/EX3/EX4/NX5xx)
 - Wall-mount bracket SU-WL100 (KDL-26EX3xx, KDL-22EX3xx)
- Be sure to use the screws supplied with the Wall-mount bracket when attaching the mounting hooks to the TV set. The supplied screws are designed so that they are 8 mm to 12 mm in length when measured from the attaching surface of the mounting hook. The diameter and length of the screws differ depending on the Wall-mount bracket model. Use of screws other than those supplied may result in internal damage to the TV set or cause it to fall, etc.

8 mm - 12 mm

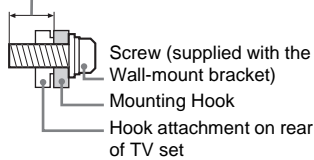

Transporting

- Before transporting the TV set, disconnect all cables.
 - Two or three people are needed to transport a large TV set.
 - When transporting the TV set by hand, hold it as shown on the right. Do not put stress on the LCD panel.
 - When lifting or moving the TV set, hold it firmly from the bottom.
 - When transporting the TV set, do not subject it to jolts or excessive vibration.
 - When transporting the TV set for repairs or when moving, pack it using the original carton and packing material.
-

Ventilation

- Never cover the ventilation holes or insert anything in the cabinet.

- Leave space around the TV set as shown below.
- It is strongly recommended that you use a Sony wall-mount bracket in order to provide adequate air-circulation.

Installed on the wall

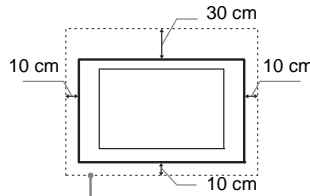

Leave at least this space around the set.

Installed with stand

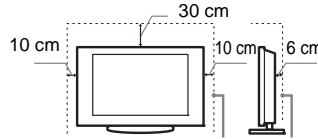

Leave at least this space around the set.

- To ensure proper ventilation and prevent the collection of dirt or dust:
 - Do not lay the TV set flat, install upside down, backwards, or sideways.
 - Do not place the TV set on a shelf, rug, bed or in a closet.
 - Do not cover the TV set with a cloth, such as curtains, or items such as newspapers, etc.
 - Do not install the TV set as shown below.

Air circulation is blocked.

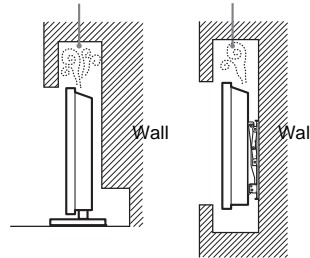

Mains lead

Handle the mains lead and socket as follows in order to avoid any risk of fire, electrical shock or damage and/or injuries:

- Use only mains leads supplied by Sony, not other suppliers.
- Insert the plug fully into the mains socket.
- Operate the TV set on a 220–240 V AC supply only.
- When wiring cables, be sure to unplug the mains lead for your safety and take care not to catch your feet on the cables.
- Disconnect the mains lead from the mains socket before working on or moving the TV set.
- Keep the mains lead away from heat sources.
- Unplug the mains plug and clean it regularly. If the plug is covered with

dust and it picks up moisture, its insulation may deteriorate, which could result in a fire.

Notes

- Do not use the supplied mains lead on any other equipment.
- Do not pinch, bend, or twist the mains lead excessively. The core conductors may be exposed or broken.
- Do not modify the mains lead.
- Do not put anything heavy on the mains lead.
- Do not pull on the mains lead itself when disconnecting the mains lead.
- Do not connect too many appliances to the same mains socket.
- Do not use a poor fitting mains socket.

Prohibited Usage

Do not install/use the TV set in locations, environments or situations such as those listed below, or the TV set may malfunction and cause a fire, electrical shock, damage and/or injuries.

Location:

Outdoors (in direct sunlight), at the seashore, on a ship or other vessel, inside a vehicle, in medical institutions, unstable locations, near water, rain, moisture or smoke.

Environment:



- To prevent the spread of fire, keep candles or other open flames away from this product at all time.
- Places that are hot, humid, or excessively dusty; where insects may enter; where it might be exposed to mechanical vibration, near flammable objects (candles, etc). The TV set shall not be exposed to dripping or splashing and no objects filled with liquids, such as vases, shall be placed on the TV.

Situation:

Do not use when your hands are wet, with the cabinet removed, or with attachments not recommended by the manufacturer. Disconnect the TV set from mains socket and aerial during lightning storms.

Broken pieces:

- Do not throw anything at the TV set. The screen glass may break by the impact and cause serious injury.
- If the surface of the TV set cracks, do not touch it until you have unplugged the mains lead. Otherwise electric shock may result.

When not in use

- If you will not be using the TV set for several days, the TV set should be disconnected from the mains for environmental and safety reasons.
- As the TV set is not disconnected from the mains when the TV set is just turned off, pull the plug from the mains to disconnect the TV set completely.
- However, some TV sets may have features that require the TV set to be left in standby to work correctly.

Continued

For children

- Do not allow children to climb on the TV set.
- Keep small accessories out of the reach of children, so that they are not mistakenly swallowed.

If the following problems occur...

Turn off the TV set and unplug the mains lead immediately if any of the following problems occur.

Ask your dealer or Sony service centre to have it checked by qualified service personnel.

When:

- Mains lead is damaged.
- Poor fitting of mains socket.
- TV set is damaged by being dropped, hit or having something thrown at it.
- Any liquid or solid object falls through openings in the cabinet.

Precautions

Viewing the TV

- View the TV in moderate light, as viewing the TV in poor light or during long period of time, strains your eyes.
- When using headphones, adjust the volume so as to avoid excessive levels, as hearing damage may result.

LCD Screen

- Although the LCD screen is made with high-precision technology and 99.99% or more of the pixels are effective, black dots may appear or bright points of light (red, blue, or green) may appear constantly on the LCD screen. This is a structural property of the LCD screen and is not a malfunction.
- Do not push or scratch the front filter, or place objects on top of this TV set. The image may be uneven or the LCD screen may be damaged.
- If this TV set is used in a cold place, a smear may occur in the picture or the picture may become dark. This does not indicate a failure. These phenomena disappear as the temperature rises.
- Ghosting may occur when still pictures are displayed continuously. It may disappear after a few moments.
- The screen and cabinet get warm when this TV set is in use. This is not a malfunction.
- The LCD screen contains a small amount of liquid crystal. Some fluorescent tubes used in this TV set also contain mercury. Follow your local ordinances and regulations for disposal.

Handling and cleaning the screen surface/cabinet of the TV set

Be sure to unplug the mains lead connected to the TV set from mains socket before cleaning.

To avoid material degradation or screen coating degradation, observe the following precautions.

- To remove dust from the screen surface/cabinet, wipe gently with a soft cloth. If dust is persistent, wipe with a soft cloth slightly moistened with a diluted mild detergent solution.
- Do not spray water or detergent directly on the TV set. It may drip to the bottom of the screen or exterior parts, and may cause a malfunction.
- Never use any type of abrasive pad, alkaline/acid cleaner, scouring powder, or volatile solvent, such as alcohol, benzene, thinner or insecticide. Using such materials or maintaining prolonged contact with rubber or vinyl materials may result in damage to the screen surface and cabinet material.
- Periodic vacuuming of the ventilation openings is recommended to ensure to proper ventilation.
- When adjusting the angle of the TV set, move it slowly so as to prevent the TV set from moving or slipping off from its table stand.

Optional Equipment

- Keep optional components or any equipment emitting electromagnetic radiation away from the TV set. Otherwise picture distortion and/or noisy sound may occur.
- This equipment has been tested and found to comply with the limits set out in the EMC Directive using a connection signal cable shorter than 3 meters.

Batteries

- Observe the correct polarity when inserting batteries.
- Do not use different types of batteries together or mix old and new batteries.
- Dispose of batteries in an environmentally friendly way. Certain regions may regulate the disposal of batteries. Please consult your local authority.
- Handle the remote with care. Do not drop or step on it, or spill liquid of any kind onto it.
- Do not place the remote in a location near a heat source, a place subject to direct sunlight, or a damp room.

Disposal of the TV set



Disposal of Old Electrical & Electronic Equipment (Applicable in the European

Union and other European countries with separate collection systems)

This symbol on the product or on its packaging indicates that this product shall not be treated as household waste. Instead it shall be handed over to the applicable collection point for the recycling of electrical and electronic equipment. By ensuring this product is disposed of correctly, you will help prevent potential negative consequences for the environment and human health, which could otherwise be caused by inappropriate waste handling of this

product. The recycling of materials will help to conserve natural resources. For more detailed information about recycling of this product, please contact your local Civic Office, your household waste disposal service or the shop where you purchased the product.



Disposal of waste batteries (applicable in the European Union and other European countries with separate collection systems)









This symbol on the battery or on the packaging indicates that the battery provided with this product shall not be treated as household waste. On certain batteries this symbol might be used in combination with a chemical symbol. The chemical symbols for mercury (Hg) or lead (Pb) are added if the battery contains more than 0.0005% mercury or 0.004% lead. By ensuring these batteries are disposed of correctly, you will help prevent potentially negative consequences for the environment and human health which could otherwise be caused by inappropriate waste handling of the battery. The recycling of the materials will help to conserve natural resources. In case of products that for safety, performance or data integrity reasons require a permanent connection with an incorporated battery, this battery should be replaced by qualified service staff only. To ensure that the battery will be treated properly, hand over the product at end-of-life to the applicable collection point for the recycling of electrical and electronic equipment. For all other batteries, please view the section on how to remove the battery from the product safely. Hand the battery over to the applicable collection point for the recycling of waste batteries. For more detailed information about recycling of this product or battery, please contact your local Civic Office, your household waste disposal service or the shop where you purchased the product.

? *Instruction Manual*

Instruction Manual

Displays the instruction manual on the screen.

Navigating through the Instruction Manual

- 1** Press **i-MANUAL**.
- 2** Press  to select topic from the Table of Contents, then press .
Use the corresponding coloured button to go to next or previous page and to return to Table of Contents.
If the explanation is linked to other topic, the symbol  will appear. Press / to select  then press . Press  **RETURN** to go back.
- 3** Press  **RETURN** to exit.



- The XMB™ (XrossMediaBar) is a menu of BRAVIA features and input sources displayed on the TV screen.

Overview of the remote

-
- 1** I/O – TV standby
Turns the TV on and off from standby mode.
 - 2** Screen mode (page 16)
 - 3** Digital Favourite list
Press to display the Digital Favourite list that you have specified (page 18).
 - 4** Info/Text reveal
 - In digital mode: Displays brief details of the programme currently being watched.
 - In analogue mode: Displays information such as current channel number and screen format.
 - In Text mode (page 16): Reveals hidden information (e.g. answers to a quiz).
 - 5** Navigation arrows
 - 6** OPTIONS (page 16, 21)
Enables you to access various viewing options and change/make adjustments according to the source and screen format.
 - 7** HOME (page 23)
 - 8** Coloured buttons (page 16, 18)
 - 9** Number buttons
 - In TV mode: Selects channels. For channel numbers 10 and above, press the second and third digit in quick succession.
 - In Text mode: Enters the three digit page number to select the page.
 - 10** Subtitle setting
Press to change the subtitle language (page 30) (in digital mode only).
 - 11** AUDIO
Press to change the dual sound mode (page 25).
 - 12** PROG +/-/EA/ET
 - In TV mode: Selects the next (+) or previous (-) channel.
 - In Text mode (page 16): Selects the next (EA) or previous (ET) page.
 - 13** +/- – Volume
 - 14** Mute the sound
 - 15** Text (page 16)
 - 16** RETURN /
 - Returns to the previous screen of any displayed menu.
 - 17** GUIDE / – EPG (Digital Electronic Programme Guide) (page 17)
 - 18** DIGITAL – Digital mode (page 15)
ANALOG – Analogue mode (page 15)
 - 19** SCENE – Scene Select (page 16)
 - 20** i-MANUAL
Displays contents of Instruction Manual on the screen.
 - 21** THEATRE
 - 22** SYNC MENU

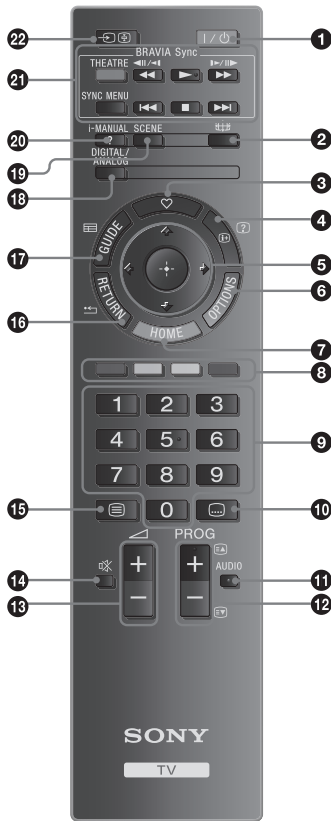

21 BRAVIA Sync

◀◀/▶▶/▶▶▶▶/◀◀◀◀/■/▶▶▶▶: You can operate the BRAVIA Sync-compatible equipment that is connected to the TV.

SYNC MENU: Displays the menu of connected HDMI equipment. While viewing other input screens or TV programmes, “HDMI Device Selection” is displayed when the button is pressed.

THEATRE: You can set Theatre Mode to on or off. When Theatre Mode is set to on, the optimum sound quality (if the TV is connected with an audio system using an HDMI cable) and picture quality for film-based contents are automatically set.



- If you turn the TV off, Theatre Mode is also turned off.
- When you change the “Scene Select” setting, Theatre Mode turns off automatically.
- “Control for HDMI” (BRAVIA Sync) is only available with the connected Sony equipment that has the BRAVIA Sync or BRAVIA Theatre Sync logo or is compatible with Control for HDMI.

22 →/Ⓜ – (Input select)

- In TV mode: Press to display a list of inputs.



- The number 5, **PROG +** and **AUDIO** buttons have tactile dots. Use the tactile dots as references when operating the TV.

Overview of the TV buttons and indicators

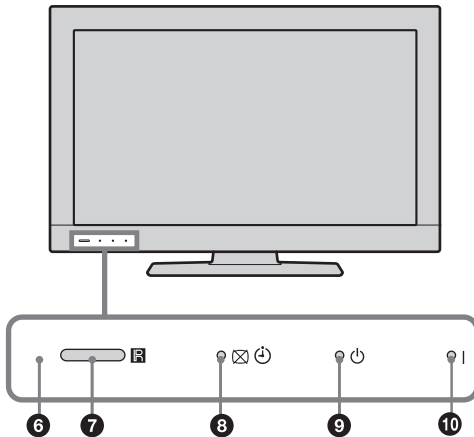
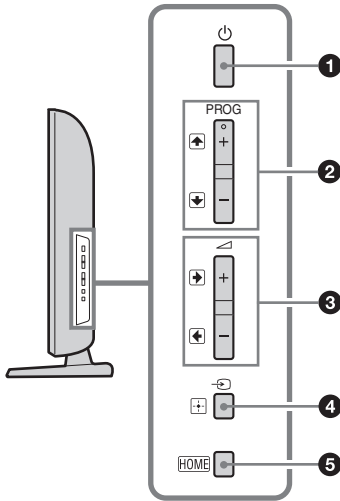

1 – Power

Turns the TV on or off.



- To disconnect the TV completely, pull the plug from the mains.
- When you turn on the TV, the power indicator lights in green.

2 **PROG** +/-//

- In TV mode: Selects the next (+) or previous (-) channel.
- In TV menu: Moves through the options up () or down ()

3 +/-//

- In TV mode: Increases (+) or decreases (-) the volume.
- In TV menu: Moves through the options right () or left ()

4 / – Input select / OK

- In TV mode: Selects the input source from equipment connected to the TV sockets (page 20).
- In TV menu: Selects the menu or option, and confirms the setting.

5 **HOME** (page 23)

6 Light sensor

Do not put anything over the sensor, doing so may affect its function (page 26).

7 Remote control sensor

- Receives IR signals from the remote.
- Do not put anything over the sensor, as its function may be affected.

8 – Picture Off / Sleep Timer indicator

- Lights up in green when the picture is switched off (page 26).
- Lights up in orange when the sleep timer is set (page 26).

9 – Standby indicator

Lights up in red when the TV is in standby mode.

10 **I** – Power indicator

Lights up in green when the TV is turned on.



- Make sure that the TV is completely turned off before unplugging the mains lead. Unplugging the mains lead while the TV is turned on may cause the indicator to remain lit or may cause the TV to malfunction.

Watching TV

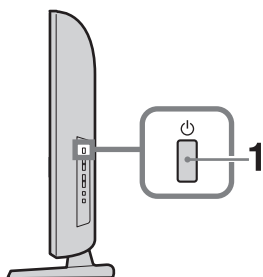

- 1 Press on the side of the TV to turn on the TV.

When the TV is in standby mode (the (standby) indicator on the TV front panel is red), press on the remote to turn on the TV.

- 2 Press **DIGITAL/ANALOG** to switch between digital and analogue modes.

The channels available vary depending on the mode.

- 3 Press the number buttons or **PROG +/-** to select a TV channel.

To select channel numbers 10 and above using the number buttons, press the second and third digits in quick succession.

To select a digital channel using the Digital Electronic Programme Guide (EPG), see page 17.

In digital mode

An information banner appears briefly. The following icons may be indicated on the banner.

- : Radio service
- : Scrambled/Subscription service
- : Multiple audio languages available
- : Subtitles available
- : Subtitles available for the hearing impaired
- : Recommended minimum age for current programme (from 4 to 18 years)
- : Parental Lock
- : Digital Programme Lock

Additional operations

To	Do this
Adjust the volume	Press + (increase)/ - (decrease).
Access the Programme index table (in analogue mode only)	Press . To select an analogue channel, press , then press .
Access the Digital Favourites (in digital mode only)	Press . For details, see page 18.

To access Text

Press . Each time you press , the display changes cyclically as follows:

Text → Text over the TV picture (mix mode) → No Text (exit the Text service)

To select a page, press the number buttons or /.

To reveal hidden information, press .



- When four coloured items appear at the bottom of the Text page, Fastext is available. Fastext allows you to access pages quickly and easily. Press the corresponding coloured button to access the page.

Scene Select mode

When you select the desired scene option, the optimum sound quality and picture quality for the selected scene are automatically set.

- 1 Press SCENE on the remote control.
- 2 Press /// to select the mode, then press .

Cinema: Delivers a theatre-like picture and sound.

Sports: Delivers a realistic picture with surround sound.

Photo: Delivers a picture that reproduces the texture and colour of a printed photo.

Game: Delivers a picture that lets you enjoy game-playing to the fullest with the best picture and sound quality.

Graphics: Delivers picture scenes that ease your prolonged monitor viewing experience and reduce fatigue by displaying clearer detailed pictures.

General: Current user settings.

Auto HDMI: The optimum sound quality and picture quality are automatically set according to the input source, though there may not be any effect depending on the connected devices.



- Except for “General”, if any scene mode is selected, picture mode selection in the picture menu is not possible - release scene selection first.
- When you set Theatre Mode (page 13) to on, the “Scene Select” setting switches to “Cinema” automatically.

To change the screen format manually to suit the broadcast

Press repeatedly to select the desired screen format.

Smart*

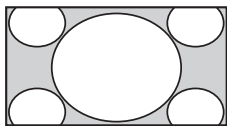

Displays conventional 4:3 broadcasts with an imitation wide screen effect. The 4:3 picture is stretched to fill the screen.

4/3

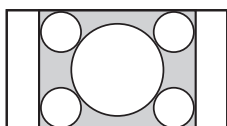

Displays conventional 4:3 broadcasts (e.g. non-wide screen TV) in the correct proportions.

Wide

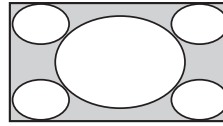

Stretches a 4:3 picture horizontally, to fill a 16:9 screen.

Zoom*

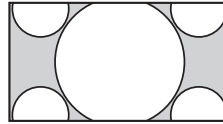

Displays cinemascopic (letter box format) broadcasts in the correct proportions.

14/9*

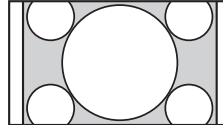

Displays 14:9 broadcasts in the correct proportions. As a result, black border areas are visible on the screen.

Subtitle*

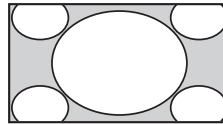

Displays cinemascopic (letter box format) broadcasts with subtitles on the screen.

Auto

- “Screen Format” is set to “Auto”, automatically changes the screen format to suit the broadcast signal.

* Parts of the top and bottom of the picture may be cut off.



- Depending on the signal, some screen formats may not be selectable.
- Some characters and/or letters at the top and the bottom of the picture may not be visible in “Smart”.



- You can adjust the vertical position of the picture when selecting “Zoom”, “14/9” or “Subtitle”. Press / to move up or down (e.g. to read subtitles).

Using the OPTIONS menu

Press OPTIONS to display the following options when viewing a TV programme.

Options	Description
Picture	See page 24.
Sound	See page 25.
Speaker	See page 26.
Lock/Unlock (in digital mode only)	Lock/Unlock the selected channel. See “Parental Lock” for PIN Code (page 31).
Audio Language (in digital mode only)	See page 31.
Subtitle Setting (in digital mode only)	See page 30.
Sleep Timer	See page 26.
Power Saving	See page 26.
System Information (in digital mode only)	Displays the system information on screen.

Using the Digital Electronic Programme Guide (EPG) DV3*

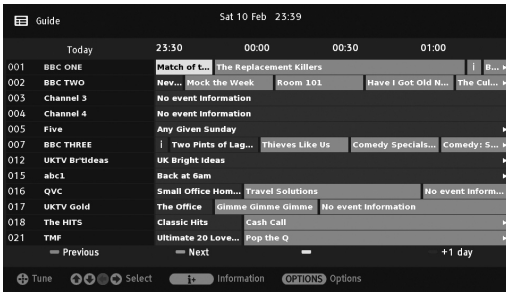

- 1 In digital mode, press GUIDE.
- 2 Perform the desired operation as shown in the following table or displayed on the screen.

Digital Electronic Programme Guide (EPG)

* This function may not be available in some countries/regions.

To	Do this
Watch a programme	Press $\uparrow/\downarrow/\leftarrow/\rightarrow$ to select the programme, then press \oplus .
Turn off the EPG	Press GUIDE.



- If an age restriction for programmes has been selected, a message asking for a PIN code will appear on the screen. For details, see “Parental Lock” on page 31.

Using the Digital Favourite list DV3*

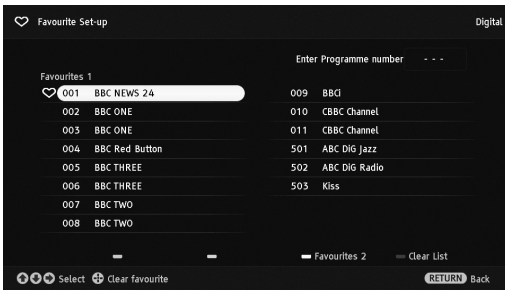

The Favourite feature allows you to specify up to four lists of your favourite programmes.

- 1 In digital mode, press ♥.
- 2 Perform the desired operation as shown in the following table or displayed on the screen.

Digital Favourite list

* This function may not be available in some countries/regions.

To	Do this
Create your Favourite list for the first time	<ol style="list-style-type: none"> 1 Press ⊕ to select "Yes". 2 Press the yellow button to select the Favourite list. 3 Press ⬆/⬇/⬅/➡ to select the channel you want to add, then press ⊕. Channels that are stored in the Favourite list are indicated by a ♥ symbol. 4 Press ⏪ RETURN to finish setting up.
Watch a channel	<ol style="list-style-type: none"> 1 Press the yellow button to navigate through your Favourite lists. 2 Press ⬆/⬇ to select the channel, then press ⊕.
Turn off the Favourite list	Press ⏪ RETURN.
Add or remove channels in the currently edited Favourite list	<ol style="list-style-type: none"> 1 Press the blue button. 2 Press the yellow button to select the Favourite list you want to edit. 3 Press ⬆/⬇/⬅/➡ to select the channel you want to add or remove, then press ⊕.
Remove all channels from the current Favourite list	<ol style="list-style-type: none"> 1 Press the blue button. 2 Press the yellow button to select the Favourite list you want to edit. 3 Press the blue button. 4 Press ⬅/➡ to select "Yes", then press ⊕ to confirm.

Using Optional Equipment

Connecting optional equipment

You can connect a wide range of optional equipment to your TV. Connecting cables are not supplied.

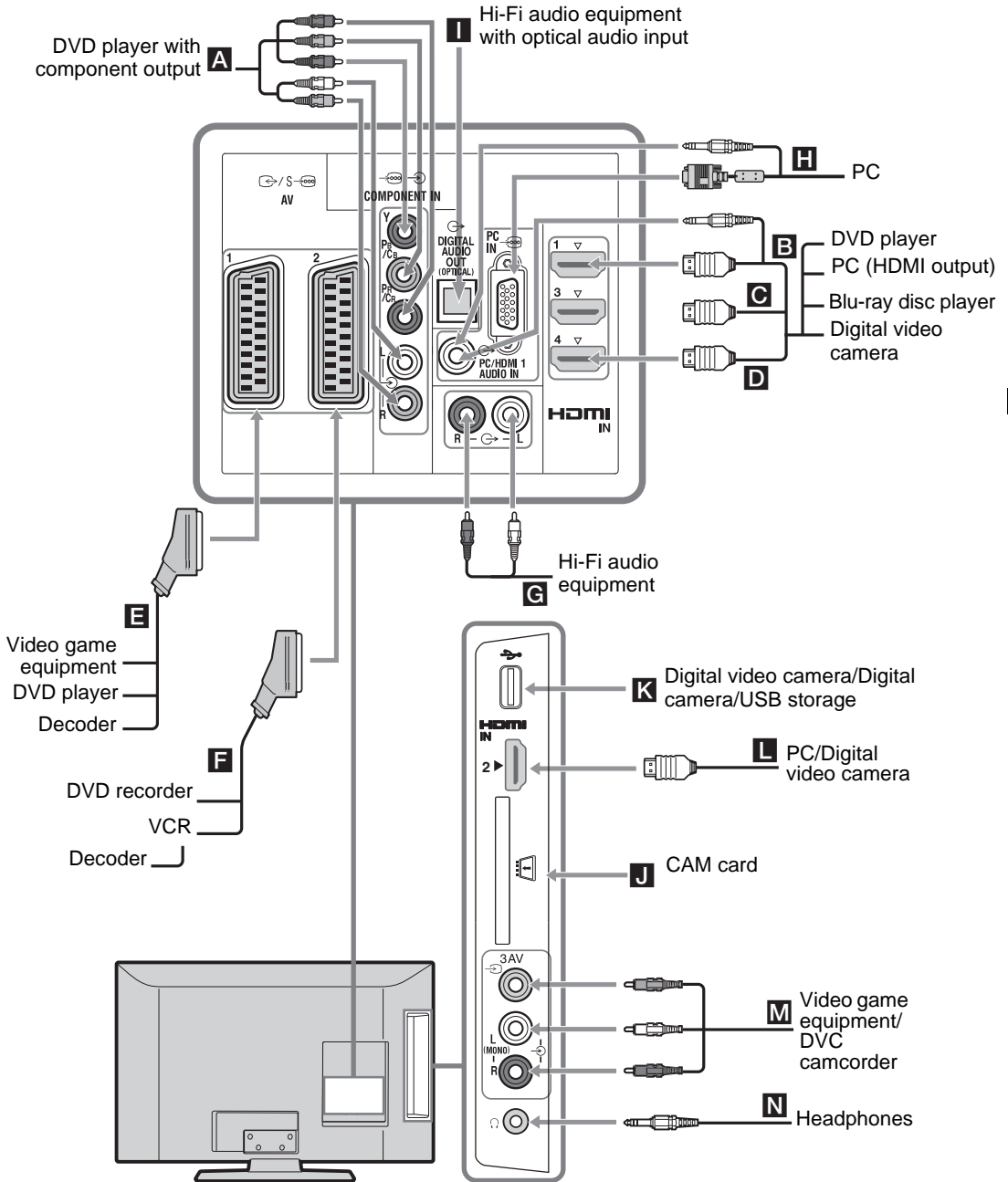

Viewing pictures from connected equipment

Turn on the connected equipment, then perform one of the following operation.

For an auto-tuned VCR page 7

In analogue mode, press PROG +/-, or the number buttons, to select the video channel.

For other connected equipment

Press to display the connected equipment list. Press to select the desired input source, then press . (The highlighted item is selected if two seconds pass without any operation after pressing .

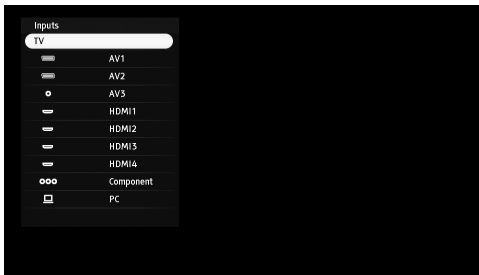

For a USB device

See page 21.

Symbol on the screen	Description
Component	To see the equipment connected to A .
HDMI1, HDMI2, HDMI3 or HDMI4	HDMI IN 1, HDMI IN 2, HDMI IN 3 or HDMI IN 4 To see the equipment connected to B , C , D or L . Digital video and audio signals are input from the connected equipment. If the equipment has a DVI socket, connect the DVI socket to the HDMI IN 1 socket through a DVI-HDMI adaptor interface (not supplied), and connect the equipment's audio out sockets to the audio in sockets in the HDMI IN 1 sockets. Connect to the HDMI IN 2 socket, to view photographs or screen images from a PC or digital video camera.
AV1	To see the equipment connected to E .

Symbol on the screen	Description
AV2	To see the equipment connected to F .
PC	To see the equipment connected to H . <ul style="list-style-type: none"> It is recommended to use a PC cable with ferrites like the "Connector, D-sub 15" (ref. 1-793-504-11, available in Sony Service Centre), or equivalent.
USB	To see the equipment connected to K . You can enjoy photo/music/video files stored in a Sony digital still camera or camcorder (page 21).
AV3	To see the equipment connected to M . When connecting mono equipment, connect to the AV3 L socket.
	<ul style="list-style-type: none"> Be sure to use only an authorised HDMI cable bearing the HDMI logo. We recommend that you use a Sony HDMI cable. When HDMI control compatible equipment is connected, communication with the connected equipment is supported. Refer to page 22 to set up this communication.
To connect	Do this
Conditional Access Module (CAM) J	To use Pay Per View services. For details, refer to the instruction manual supplied with your CAM. Turn off the TV when inserting or removing your CAM. <ul style="list-style-type: none"> CAM is not supported in some countries/regions. Check with your authorised dealer.
Hi-Fi audio equipment G	Connect to the audio output sockets to listen to the sound from the TV on Hi-Fi audio equipment. Audio level of the external speakers can be modified by pressing the volume buttons on the remote control.
DIGITAL AUDIO OUT (OPTICAL) I	Use an optical audio cable.
Headphones N	Connect to the socket to listen to sound from the TV on headphones.

Additional operation

To	Do this
Return to normal TV mode	Press DIGITAL/ANALOG .

Using the OPTIONS menu

Press **OPTIONS** to display the following options when viewing pictures from connected equipment.

Options	Description
Picture	See page 24.
Sound	See page 25.
Speaker	See page 25.
Horizontal Shift (in PC input mode only)	See page 27.
Vertical Shift (in PC input mode only)	See page 27.
Sleep Timer (except PC input mode)	See page 26.
Power Saving	See page 26.

Playing Back Photo/Music/Video via USB

You can enjoy photo/music/video files stored in a Sony digital still camera or camcorder through a USB cable or USB storage device on your TV.

- 1 Connect a supported USB device to the TV.
- 2 Press **HOME**.
- 3 Press \leftarrow/\rightarrow to select “Photo”, “Music”, or “Video”.
- 4 Press \uparrow/\downarrow to select a USB device, then press \oplus .
The file or folder list appears.
- 5 Press $\uparrow/\downarrow/\leftarrow/\rightarrow$ to select a file or folder, then press \oplus .
When you select a folder, select a file, then press \oplus .
Playback starts.



- You can register the background music to be played during a slideshow using  Photo by pressing **OPTIONS**, then select “Slideshow Music”.
- Picture quality may appear coarse when using “Photo” because images may be enlarged depending on the file. Also, images may not fill the entire screen depending on the image size and aspect ratio.
- Some photo files may take some time to be displayed when using “Photo”.
- The file name and folder name support the UTF-8 character set.
- While the TV is accessing the data on the USB device, observe the following:
 - Do not turn off the TV or connected USB device.
 - Do not disconnect the USB cable.
 - Do not remove the USB device.The data on the USB device may be damaged.
- Sony will not be held liable for any damage to, or loss of, data on the recording media due to a malfunction of any connected devices or the TV.
- USB playback is supported for the following photo file formats:
 - JPEG (JPEG format files with the extension “.jpg” and conforming to DCF 2.0 or Exif 2.21)
- When you connect a Sony digital still camera, set the camera’s USB connection mode to Auto or “Mass Storage”. For more information about USB connection mode, refer to the instructions supplied with your digital camera.
- USB playback is supported for the following music file formats:
 - MP3 (files with the extension “.mp3” that have not been copyrighted)
- USB playback is supported for the following video file format:
 - MPEG1 (files with the extension “.mpeg”)
 - MP4 (files with the extension “.mp4”)
 - DivX (files with the extension “.avi”)
- USB Photo Viewer supports FAT16 and FAT32 file systems.
- BRAVIA TV supports DivX®.

Continued

Using MENU Functions







Navigating through TV Home Menu on XMB™

The XMB™ (XrossMediaBar) is a menu of BRAVIA features and input sources displayed on the TV screen. The XMB™ is an easy way to select programming and adjust settings on your BRAVIA TV.

- 1 Press HOME to display the XMB™.



- 2 Press \leftarrow/\rightarrow to select the category.

Media category icon	Description
 Settings	You can make advanced settings and adjustments (page 24).
 Photo	You can enjoy photo files via USB devices (page 21).
 Music	You can enjoy music files via USB devices (page 21).
 Video	You can enjoy video files via USB devices (page 21).
 Digital	You can select a digital channel, Digital Favourite list (page 18) and the Digital Electronic Programme Guide (EPG) (page 17).
 Analogue	You can select an analogue channel or Analogue Favourite list (page 18).
 External Inputs	You can select equipment connected to the TV. To assign a label to an external input, see “AV Preset” (page 28).

- 3 Press \uparrow/\downarrow to select the item, then press \oplus .
- 4 Follow the instructions on the screen.
- 5 Press \leftarrow RETURN to exit.



- The options you can adjust vary depending on the situation.
- Unavailable options are greyed out or not displayed.

Settings







System Update

System Update

You can update the TV system using USB memory. Obtain information from the website below.
<http://support.sony-europe.com/TV/>

Instruction Manual

Instruction Manual

Displays contents of Instruction Manual on the screen.
Use coloured buttons to move through the screens.
Press /// to select , then press  to go to related item or access real application.

Picture

Picture Mode

Selects the picture mode.
“**Vivid**”: For enhanced picture contrast and sharpness.
“**Standard**”: For standard picture. Recommended for home entertainment.

- "Picture Mode" is set depending on "Scene Select" settings.
- "Vivid" and "Standard" are available when "General" is selected in "Scene Select" mode.

Backlight

Adjusts the brightness of the backlight.

- Reducing the brightness of the screen, the power consumption will be reduced.

Contrast

Increases or decreases picture contrast.

Brightness

Brightens or darkens the picture.

Colour

Increases or decreases colour intensity.

Hue

Increases or decreases the green tones and red tones.

- “Hue” can only be adjusted for an NTSC colour signal (e.g., U.S.A. video tapes).

Sharpness

Sharpens or softens the picture.

Colour Temperature

Adjusts the whiteness of the picture.
“**Cool**”: Gives the white colours a blue tint.
“**Neutral**”: Gives the white colours a neutral tint.
“**Warm**”: Gives the white colours a red tint.



- “Warm” can not be selected when you set “Picture Mode” to “Vivid”.

Noise Reduction	Reduces the picture noise (snowy picture) in a weak broadcast signal. “High/Medium/Low” : Modifies the effect of the noise reduction. “Off” : Turns off the “Noise Reduction” feature.
MPEG Noise Reduction	Reduces the picture noise in MPEG-compressed video.
Advanced Settings	Customizes the Picture function in more detail. “Adv. Contrast Enhancer” : Automatically adjusts “Backlight” and “Contrast” to the most suitable settings judging from the brightness of the screen. This setting is especially effective for dark images scenes, and will increase the contrast distinction of the darker picture scenes. “Auto Light Limiter” : Reduces glare such as in scenes where the entire screen is white. “Live Colour” : Makes colours more vivid.
Reset	Resets all “Picture” settings except “Picture Mode” to the factory settings.



- “Noise Reduction” and “MPEG Noise Reduction” are not available when “Picture Mode” is set to “Photo”.
- “Advanced Settings” is not available when “Picture Mode” is set to “Vivid” or for USB (Photo/Music) input.



Sound

Sound Effect	Selects the sound mode. “Dynamic” : Intensifies clarity and sound presence for better intelligibility and musical realism. “Standard” : Enhances clarity, detail, and sound presence. “Clear Voice” : Makes voice sound clearer.
Surround	Selects the surround mode. “Surround” : For surround sound (for stereo programmes only). “Simulated Stereo” : Adds a surround-like effect to mono programs. “Off” : For normal stereo or mono reception.
Treble	Adjusts higher-pitched sounds.
Bass	Adjusts lower-pitched sounds.
Balance	Emphasizes left or right speaker balance.
Reset	Resets all the “Sound” settings to the factory settings.
Dual Sound	Selects the sound from the speaker for a stereo or bilingual broadcast. “Stereo”, “Mono” : For a stereo broadcast. “A”/“B”/“Mono” : For a bilingual broadcast, select “A” for sound channel 1, “B” for sound channel 2, or “Mono” for a mono channel, if available.  <ul style="list-style-type: none"> • If you select other equipment connected to the TV, set “Dual Sound” to “Stereo”, “A” or “B”.
Auto Volume	Keeps a constant volume level even when volume level gaps occur (e.g., adverts tend to be louder than programmes).

Volume Offset	Sets an independent volume level to each equipment connected to the TV.
Speaker	Turns on/off the TV's internal speakers. "TV Speaker" : The TV speakers are turned on in order to listen to the TV's sound through the TV speakers. "Audio System" : The TV speakers are turned off in order to listen to the TV's sound only through your external audio equipment connected to the audio output sockets.
PC Audio Input	Selects the sound from the connected equipment HDMI 1 (DVI-HDMI) or PC (page 20).
Advanced Settings	<p>"Dynamic Range": Compensates for differences in the audio level between different channels (only for Dolby Digital audio).</p> <p> • The effect may not function or may vary depending on the programme regardless of the "Dynamic Range" setting.</p> <p>"Optical Out": Sets the audio signal that is output from the DIGITAL AUDIO OUT (OPTICAL) jack of the TV. Set to "Auto", when connecting equipment compatible with Dolby Digital. Set to "PCM", when connecting equipment not compatible with Dolby Digital.</p> <p>"Downmix Mode": Set the downmix method of multi-channel to two-channel sound.</p> <ul style="list-style-type: none"> • "Surround": Select to get best surround performance, or while using external products with Pro Logic. • "Stereo": Select to get a stereo output.

-  • "Sound Effect", "Surround", "Treble", "Bass", "Balance", "Reset" and "Auto Volume" are not available when "Speaker" is set to "Audio System".

Eco

Power Saving	Selects the power saving mode to reduce the power consumption of the TV. "Standard" : Default settings. "Reduce" : Reduces the power consumption of the TV. "Picture Off" : Switches off the picture. You can listen to the sound with the picture off.
Sleep Timer	Sets a period of time after which the TV automatically switches itself into standby mode. When the "Sleep Timer" is activated, the  (Sleep Timer) indicator on the TV front panel lights up in orange.  • When you turn off the TV and turn it on again, "Sleep Timer" is reset to "Off". • A notification message appears on the screen one minute before the TV switches to standby mode.
Idle TV Standby	Selects the time ("1h", "2h" or "4h") to set the TV into standby mode automatically, if you do not operate the TV for the specified period of time.
PC Power Management	When this is set to "On," turns to standby mode if no PC signal is received. Only available in PC input.
Light sensor	Automatically optimises the picture settings according to the ambient light in the room.  • Do not put anything over the sensor, doing so may affect its function. Check the position of the sensor (page 14).

Reset Resets all the “Eco” settings to the factory settings.



- Energy efficiency reduces power consumption and thus saves money by reducing electricity bills.

Screen

Screen Format Changes the screen format. For details about the screen format, see page 16.

Screen Format (only in PC mode)

“**Normal**”: Displays the picture in its original size.
“**Full 1**”: Enlarges the picture to fill the vertical display area, while maintaining its original proportion.
“**Full 2**”: Enlarges the picture to fill the display area.

Screen Format (only in USB (Video) mode)

“**Normal**”: Displays the picture in its original size.
“**Zoom**”: Enlarges the picture.

RGB Centre Adjusts the horizontal picture position so that the picture is in the middle of the screen.

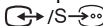
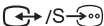

- This option is only available if an RGB source has been connected to the Scarts connectors  AV1 or  AV2 on the rear of the TV.

PC Adjustment Customizes the TV screen as a PC monitor.



- This option is only available if a PC signal is received.

“**Phase**”: Adjusts the screen when a part of a displayed text or image is not clear.
“**Pitch**”: Enlarges or shrinks the screen size horizontally.
“**Horizontal Shift**”: Moves the screen to the left or to the right.
“**Vertical Shift**”: Moves the screen up or down.
“**Reset**”: Resets to the factory settings.

Display Area Adjusts the picture display area.

“**Full Pixel**” (except for KDL-32BX3xx, 32EX3xx, 26EX3xx, 22EX3xx): Displays pictures in their original size when parts of the picture are cut off.
“**Normal**”: Displays pictures in their recommended size.
“**+1**”: Displays pictures in their original size.



- These options may change depending on the input displayed.

Vertical Shift Adjusts the vertical position of the picture when “Screen Format” is set to “Zoom”, “14:9” or “Subtitle”.

Vertical Size Adjusts the vertical size of the picture when “Screen Format” is set to “Smart”.



Auto Start-up	Starts the initial set-up to select the language, country/region and location, and tune in all available digital and analogue channels. Usually, you do not need to do this operation because the language and country/region will have been selected and channels already tuned when the TV was first installed. However, this option allows you to repeat the process (e.g., to retune the TV after moving house).
Language	Selects the language in which the menus are displayed.
AV Preset	<p>Assigns a name to any equipment connected to the side and rear sockets. The name will be displayed briefly on the screen when the equipment is selected.</p> <ol style="list-style-type: none">1 Press \uparrow/\downarrow to select the desired input source, then press \oplus.2 Press \uparrow/\downarrow to select the desired option below, then press \oplus.<ul style="list-style-type: none">• AV1 (or AV2/AV3/HDMI1/HDMI2/HDMI3/HDMI4/Component/PC), VIDEO, DVD, CABLE, GAME, CAM, SAT: Uses one of the preset labels to assign a name to connected equipment.• “Edit”: Creates your own label.<ol style="list-style-type: none">1 Press \uparrow/\downarrow to select the desired letter or number (“_” for a blank space), then press \rightarrow.<p>If you input a wrong character Press \leftarrow/\rightarrow to select the wrong character. Then, press \uparrow/\downarrow to select the correct character.</p><ol style="list-style-type: none">2 Repeat the procedure in step 1 until the name is completed, then press \oplus.
HDMI Set-up	<p>Allows the TV to communicate with equipment that is compatible with the control for HDMI function, and connected to the HDMI sockets of the TV. Note that communication settings must also be made on the connected equipment.</p> <p>“Control for HDMI”: Sets whether or not to link the operations of the TV and the connected equipment that is compatible with control for HDMI.</p> <p>“Auto Devices Off”: When this is set to “On”, the connected equipment that is compatible with control for HDMI turns off when you switch the TV to standby mode using the remote.</p> <p>“Auto TV On”: When this is set to “On”, the TV turns on when you turn on the connected equipment that is compatible with control for HDMI.</p> <p>“Device Control Keys”: If it is set to “Tuning Keys”, you can select a channel tuned by connected equipment and if it is set to “Menu Keys” you can navigate through the menus of the connected equipment using the remote.</p> <p>“Device List Update”: Creates or updates the “HDMI Device List”. Up to 11 compatible equipment items can be connected, and up to 5 equipment items can be connected to a single socket. Be sure to update the “HDMI Device List” when you change the connections or settings.</p> <p>“HDMI Device List”: Displays a list of connected equipment that is compatible with control for HDMI.</p>

Analogue Set-up

“Auto Tuning (Only in analogue mode)”: Tunes in all the available analogue channels. Usually you do not need to do this operation because the channels are already tuned when the TV was first installed. However, this option allows you to repeat the process (e.g., to retune the TV after moving house, or to search for new channels that have been launched by broadcasters).

“Manual Programme Preset (Only in analogue mode)”: Changes the available analogue channel setting.

Press \uparrow/\downarrow to select the programme number you want to modify. Then, press \oplus .

System

Presets programme channels manually.

1 Press \uparrow/\downarrow to select “System”, then press \oplus .

2 Press \uparrow/\downarrow to select one of the following TV broadcast systems, then press \leftarrow .

B/G: For western European countries/regions

I: For the United Kingdom

D/K: For eastern European countries/regions

L: For France



- Depending on the country/region selected for “Country”, this option may not be available.

Channel

1 Press \uparrow/\downarrow to select “Channel”, then press \oplus .

2 Press \uparrow/\downarrow to select “S” (for cable channels) or “C” (for terrestrial channels), then press \rightleftarrows .

3 Tune the channels as follows:

If you do not know the channel number (frequency)

Press \uparrow/\downarrow to search for the next available channel. When a channel has been found, the search will stop. To continue searching, press \uparrow/\downarrow .

If you know the channel number (frequency)

Press the number buttons to enter the channel number of the broadcast you want or your VCR channel number.

4 Press \oplus to jump to “Confirm”, then press \oplus .

Repeat the procedure above to preset other channels manually.

Label

Assigns a name of your choice, up to five letters or numbers, to the selected channel.

AFT

Allows you to fine-tune the selected programme number manually if you feel that a slight tuning adjustment will improve the picture quality.

Audio Filter

Improves the sound for individual channels in the case of distortion in mono broadcasts. Sometimes a non-standard broadcast signal can cause sound distortion or intermittent sound muting when watching mono programmes.

If you do not experience any sound distortion, we recommend that you leave this option set to the factory setting “Off”.



- “Audio Filter” is not available when “System” is set to “L”.

Skip

Skips unused analogue channels when you press PROG +/- to select channels. (You can still select a skipped channel using the number buttons.)

Confirm

Saves changes made to the “Manual Programme Preset” settings.

“Programme Sorting (Only in analogue mode)”: Changes the order in which the analogue channels are stored on the TV.

- 1 Press \uparrow/\downarrow to select the channel you want to move to a new position, then press \rightarrow .
- 2 Press \uparrow/\downarrow to select the new position for your channel, then press \oplus .

“Intelligent Picture”:

- “On with Indicator”: Automatically reduces the picture noise. The signal level bar is displayed when the channel is changed or the display is changed from an input screen to a TV programme.
- “On”: Automatically reduces the picture noise.
- “Off”: Turns off the “Intelligent Picture” feature.

Digital Set-up

“Digital Tuning”

- **“Digital Auto Tuning”**:

Tunes in the available digital channels.

This option allows you to retune the TV after moving house, or to search for new channels that have been launched by broadcasters. Press \oplus .

- **“Programme List Edit”**:

Removes any unwanted digital channels stored on the TV, and changes the order of the digital channels stored on the TV.

- 1 Press \uparrow/\downarrow to select the channel you want to remove or move to a new position.

Press the number buttons to enter the known three-digit programme number of the broadcast you want.

- 2 Remove or change the order of the digital channels as follows:

To remove the digital channel

Press \oplus . After a confirmation message appears, press \leftarrow to select “Yes”, then press \oplus .

To change the order of the digital channels

Press \rightarrow , then press \uparrow/\downarrow to select the new position for the channel and press \leftarrow .

- 3 Press \rightarrow RETURN.



- When “Cable” is selected this function may not be available in some countries.

- **“Digital Manual Tuning”**:

Tunes the digital channels manually.

- 1 Press the number button to select the channel number you want to manually tune, then press \uparrow/\downarrow to tune the channel.

- 2 When the available channels are found, press \oplus to store programmes.

Repeat the above procedure to manually tune other channels.



- Not available for Cable connection.

“Subtitle Set-up”

- **“Subtitle Setting”**: When “For Hard Of Hearing” is selected, some visual aids may also be displayed with the subtitles (if TV channels broadcast such information).
- **“Primary Preferred Language”**: Selects preferred language which subtitles are displayed in.
- **“Secondary Preferred Language”**: Selects secondary preferred language which subtitles are displayed in.

“Audio Set-up”

- **“Audio Type”**: Switches to broadcast for the hearing impaired when “For Hard Of Hearing” is selected.
- **“Primary Preferred Language”**: Selects the preferred language used for a programme. Some digital channels may broadcast several audio languages for a programme.
- **“Secondary Preferred Language”**: Selects the secondary preferred language used for a programme. Some digital channels may broadcast several audio languages for a programme.
- **“Audio Description”**: Provides audio description (narration) of visual information if TV channels broadcast such information.
- **“Mixing Level”**: Adjusts the TV main audio and Audio Description output levels. 
 - This option is only available when “Audio Description” is set to “On”.
- **“MPEG Audio Level”**: Adjusts the MPEG audio sound level.

“Parental Lock”



Sets an age restriction for programmes. Any programme that exceeds the age restriction can only be watched after a PIN Code is entered correctly.



- For cable operators in Netherlands, the PIN code should be entered when the programme rating is above or equal to the age you specify.

1 Press the number buttons to enter your existing PIN code.

If you have not previously set a PIN, a PIN code entry screen appears. Follow the instructions of “PIN Code” below.

2 Press  to select the age restriction or “None” (for unrestricted watching), then press .**3 Press  RETURN.****“PIN Code”****To set your PIN for the first time**

- 1 Press the number buttons to enter the new PIN code.
- 2 Press  RETURN.

To change your PIN



- 1 Press the number buttons to enter your existing PIN code.
- 2 Press the number buttons to enter the new PIN code.
- 3 Press  RETURN.



- PIN code 9999 is always accepted.

“Digital Programme Lock”

Locks/unlocks programmes and checks the status of programmes.

- 1 Press the number buttons to enter your existing PIN code or to set the new one.
- 2 Press  to navigate across the programmes and press  to change between “lock” and “unlock” status.

“DivX® VOD”

- **“DivX® VOD Registration Code”**: Displays the registration code that is required to play DivX® VOD content.
- **“DivX® VOD Deregistration Code”**: Displays the deregistration code that is required to play DivX® VOD content.

“Technical Set-up”

- **“Auto Service Update”**: Enables the TV to detect and store new digital services as they become available.
- **“System Update”**: This TV set is capable of receiving software upgrades via the broadcast signal. In order to receive upgrades the System Update option in the Technical Setup menu should be set to “On”. When an upgrade is detected the user will be informed by a series of on screen displays on how to proceed with the upgrade. Please do not disconnect the set from the mains during the installation procedure.
- **“System Information”**: Displays the current software version and the signal level.
- **“Time Zone”**: Allows you to manually select the time zone you are in, if it is not the same as the default time zone setting for your country/region.



- When “Cable” is selected this function may not be available in some countries.
- **“Auto DST”**: Sets whether or not to automatically switch between summer time and winter time.
 - “On”: Automatically switches between summer time and winter time according to the calendar.
 - “Off”: The time is displayed according to the time difference set by “Time Zone”.



- When “Cable” is selected this function may not be available in some countries.
- **“Service Replacement”**: Select “On” to automatically change the channel when broadcaster changes transmission of the viewing programme to a different channel.

“CA Module Set-up”

Allows you to access a pay TV service once you obtain a Conditional Access Module (CAM) and a view card. See page 19 for the location of the  (PCMCIA) socket.

Installing the Accessories (Wall-Mount Bracket)

To Customers:

For product protection and safety reasons, Sony strongly recommends that installing of your TV be performed by Sony dealers or licensed contractors. Do not attempt to install it yourself.

To Sony Dealers and Contractors:

Provide full attention to safety during the installation, periodic maintenance and examination of this product.

Your TV can be installed using the Wall-Mount Bracket SU-WL500 (KDL-46EX4xx, KDL-40BX4/EX4/NX5xx, KDL-37EX4xx, KDL-32BX3/BX4/EX3/EX4/NX5xx) / SU-WL100 (KDL-26EX3xx, KDL-22EX3xx) (sold separately).

- Refer to the Instructions supplied with the Wall-Mount Bracket to properly carry out the installation.
- Refer to “Detaching the Table-Top Stand from the TV” (page 8).



- Place the TV on the Table-Top Stand, when securing the Mounting Hook.

KDL-46EX4xx
KDL-40BX4/EX4/NX5xx
KDL-37EX4xx
KDL-32BX3/BX4/EX3/EX4/NX5xx

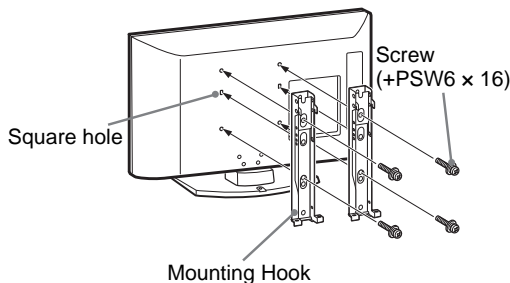

KDL-26EX3xx
KDL-22EX3xx

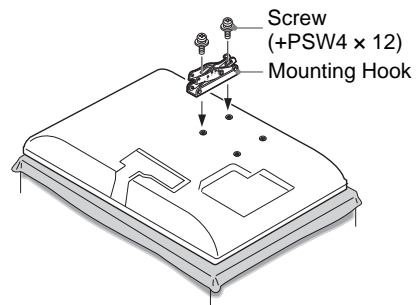

Sufficient expertise is required for installing this product, especially to determine the strength of the wall for withstanding the TV's weight. Be sure to entrust the attachment of this product to the wall to Sony dealers or licensed contractors and pay adequate attention to safety during the installation. Sony is not liable for any damage or injury caused by mishandling or improper installation.

TV installation dimensions table

KDL-46EX4xx
 KDL-40BX4/EX4/NX5xx
 KDL-37EX4xx
 KDL-32BX3/BX4/EX3/EX4/NX5xx

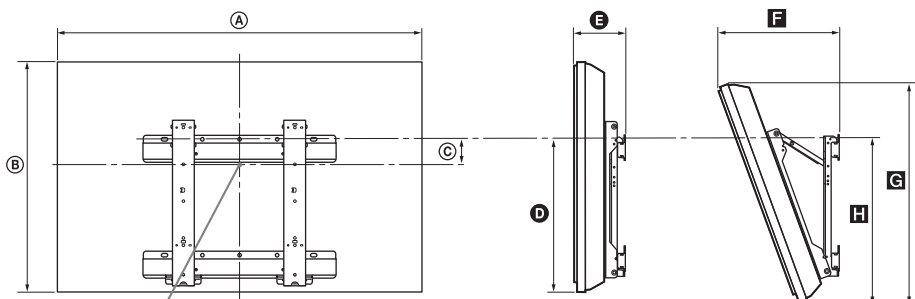

Screen centre point

KDL-26EX3xx
 KDL-22EX3xx

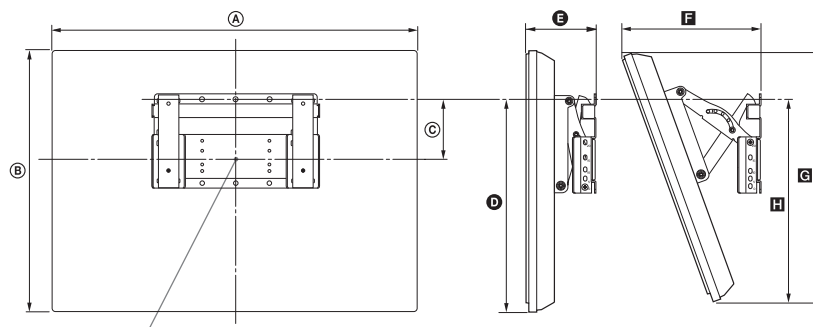

Screen centre point

Unit: cm

Model Name	Display dimensions		Screen centre dimension C	Length for each mounting angle				
	A	B		Angle (0°)		Angle (20°)		
				D	E	F	G	H
KDL-46EX4xx	112.7	67.4	8.4	42.4	16.2	36.9	64.0	46.4
KDL-40NX5xx	102.3	62.8	12.2	43.9	16.0	34.9	59.1	47.9
KDL-40BX4xx	99.6	59.8	12.2	42.5	15.9	34.1	56.6	46.2
KDL-40EX4xx	99.2	59.8	12.2	42.5	16.0	34.1	56.7	46.3
KDL-37EX4xx	92.1	56.4	14.0	42.7	15.8	32.7	53.4	46.3
KDL-32NX5xx	82.5	51.7	17.2	43.2	15.6	30.9	48.8	47.1
KDL-32BX3/BX4xx	80.4	49.7	17.2	42.6	15.6	30.3	47.9	46.0
KDL-32EX3/EX4xx	80.0	49.7	17.2	42.6	15.7	30.3	47.0	46.1
KDL-26EX3xx	67.2	42.3	9.7	31.5	16.0	26.2	40.2	32.3
KDL-22EX3xx	55.1	36.7	13.3	32.9	14.3	22.2	34.8	32.8

Figures in the above table may differ slightly depending on the installation.

WARNING

The wall that the TV will be installed on should be capable of supporting a weight of at least four times that of the TV. Refer to “Specifications” (page 36) for its weight.

Screw and Hook locations diagram/table

Model Name	Screw location	Hook location
KDL-46EX4xx	d, g	b
KDL-40BX4/EX4/NX5xx	d, g	b
KDL-37EX4xx	d, g	b
KDL-32BX3/BX4/EX3/EX4/NX5xx	e, g	c
KDL-26EX3xx	—	a
KDL-22EX3xx	—	b

KDL-46EX4xx
KDL-40BX4/EX4/NX5xx
KDL-37EX4xx
KDL-32BX3/BX4/EX3/EX4/NX5xx

Screw location

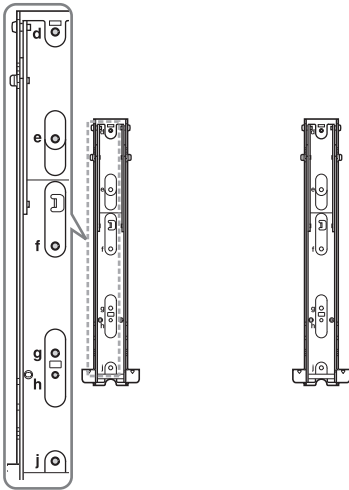

Hook location

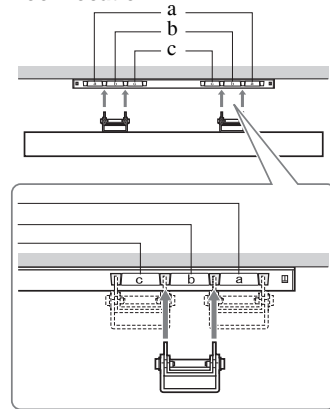





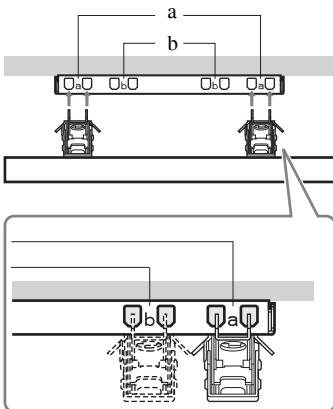



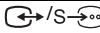
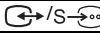

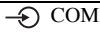
KDL-26EX3xx
KDL-22EX3xx

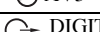
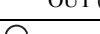
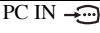
Hook location



Specifications

Model name	KDL-46EX4xx	KDL-40BX4/EX4/NX5xx	KDL-37EX4xx	KDL-32BX3/BX4/EX3/EX4/NX5xx	KDL-26EX3xx	KDL-22EX3xx	
System							
Panel System	LCD (Liquid Crystal Display) Panel						
TV System	Depending on your country/region selection Analogue: B/G/H, D/K, L, I Digital: DVB-T, DVB-C						
Colour/Video System	Analogue: PAL, PAL60 (only video input), SECAM, NTSC3.58, NTSC4.43 (only video input) Digital: MPEG-2 MP@ML/HL, H.264/MPEG-4 AVC HP@L4.0, MP@L3.0						
Channel Coverage	Analogue: 46.25 - 855.25 MHz Digital: VHF/UHF						
Sound Output	10 W + 10 W (RMS)			8 W + 8 W (RMS)	5 W + 5 W (RMS)		
Input/Output jacks							
Aerial	75 ohm external terminal for VHF/UHF						
 AV1*1	21-pin scart connector including audio/video input, RGB input, S-Video input, and Analogue TV audio/video output.						
 AV2*2	21-pin scart connector including audio/video input, RGB input, S-Video input, and audio/video output.						
 COMPONENT IN	Supported formats: 1080p, 1080i, 720p, 576p, 576i, 480p, 480i Y: 1 Vp-p, 75 ohms, 0.3V negative sync/Pb/Cb: 0.7 Vp-p, 75 ohms/ Pr/Cr: 0.7 Vp-p, 75 ohms						
 COMPONENT IN	Audio input (phono jacks)						
HDMI IN 1, 2, 3, 4	Video: 1080p, 1080p24, 1080i, 720p, 576p, 576i, 480p, 480i Audio: Two channel linear PCM 32, 44.1 and 48 kHz, 16, 20 and 24 bits, Dolby Digital PC (see page 38) Analogue audio (minijack) (HDMI 1 only)						
 AV3	Video input (phono jack)						
 AV3	Audio input (phono jacks)						
 DIGITAL AUDIO OUT (OPTICAL)	Digital optical jack (Two channel linear PCM, Dolby Digital)						
 Audio output (Left/Right) (phono jacks)	Audio output (Left/Right) (phono jacks)						
PC IN 	PC Input (15 Dsub) (see page 38) G: 0.7 Vp-p, 75 ohms, non Sync on Green/B: 0.7 Vp-p, 75 ohms/ R: 0.7 Vp-p, 75 ohms, H/V Sync: TTL level  PC audio input (minijack)						
	Headphones jack						
	USB port						
	CAM (Conditional Access Module) slot						
Power and others							
Power Requirements	220–240 V AC, 50 Hz						
Screen Size (measured diagonally)	46 inches / Approx. 117 cm	40 inches / Approx. 102 cm	37 inches / Approx. 94 cm	32 inches / Approx. 80 cm	26 inches / Approx. 66 cm	22 inches / Approx. 55 cm	
Display Resolution	1,920 dots (horizontal) × 1,080 lines (vertical) (KDL-46EX4xx, KDL-40BX4/EX4/NX5xx, KDL-37EX4xx, KDL-32BX4/EX4/NX5xx) 1,366 dots (horizontal) × 768 lines (vertical) (KDL-32BX3/EX3xx, KDL-26EX3xx, KDL-22EX3xx)						
Power consumption	in “Home”/ “Standard” mode	142 W	110 W	95 W	73 W	52 W	39 W
	in “Shop”/ “Vivid” mode	183 W	146 W	120 W	94 W	62 W	46 W

Model name		KDL-46EX4xx	KDL-40BX4/EX4/NX5xx	KDL-37EX4xx	KDL-32BX3/BX4/EX3/EX4/NX5xx	KDL-26EX3xx	KDL-22EX3xx
Standby Power Consumption*3		0.19 W					
Off mode Power Consumption		0.18 W					
Average annual energy consumption*4		207 kWh	161 kWh	139 kWh	107 kWh	76 kWh	57 kWh
Dimensions (w × h × d) (Approx.)	(with stand)	112.7 x 71.1 x 29.4 cm	102.3 x 66.5 x 31.0 cm (KDL-40NX5xx) 99.6 x 63.5 x 25.0 cm (KDL-40BX4xx) 99.2 x 63.5 x 25.0 cm (KDL-40EX4xx)	92.1 x 59.9 x 25.1 cm	82.5 x 55.4 x 26.0 cm (KDL-32NX5xx) 80.4 x 53.2 x 22.0 cm (KDL-32BX3/BX4xx) 80.0 x 53.2 x 22.0 cm (KDL-32EX3/EX4xx)	67.2 x 45.9 x 22.0 cm	55.1 x 40.2 x 21.5 cm
	(without stand)	112.7 x 67.4 x 10.2 cm	102.3 x 62.8 x 10.0 cm (KDL-40NX5xx) 99.6 x 59.8 x 9.9 cm (KDL-40BX4xx) 99.2 x 59.8 x 10.0 cm (KDL-40EX4xx)	92.1 x 56.4 x 9.8 cm	82.5 x 51.7 x 10.2 cm (KDL-32NX5xx) 80.4 x 49.7 x 9.6 cm (KDL-32BX3/BX4xx) 80.0 x 49.7 x 9.7 cm (KDL-32EX3/EX4xx)	67.2 x 42.3 x 9.9 cm	55.1 x 36.7 x 8.2 cm
Mass (Approx.)	(with stand)	20.4 kg	22.4 kg (KDL-40NX5xx) 15.6 kg (KDL-40BX4xx) 15.9 kg (KDL-40EX4xx)	13.6 kg	15.5 kg (KDL-32NX5xx) 10.7 kg (KDL-32BX3/BX4xx) 11.0 kg (KDL-32EX3/EX4xx)	8.8 kg	6.6 kg
	(without stand)	18.1 kg	19.2 kg (KDL-40NX5xx) 13.6 kg (KDL-40BX4xx) 13.9 kg (KDL-40EX4xx)	11.6 kg	13.0 kg (KDL-32NX5xx) 9.2 kg (KDL-32BX3/BX4xx) 9.5 kg (KDL-32EX3/EX4xx)	7.3 kg	6.0 kg
Supplied Accessories		Refer to "1: Checking the accessories" on page 4.					
Optional Accessories		See "Installing the Accessories (Wall-Mount Bracket)" on page 33.					

*1 AV1 outputs available only for analogue TV.

*2 AV2 outputs watching screen (except PC, HDMI, Component, USB).

*3 Specified standby power is reached after the TV finishes necessary internal processes.

*4 4 hours a day and 365 days a year.

Design and specifications are subject to change without notice.

PC Input Signal Reference Chart for PC IN

Signals	Horizontal (Pixel)	Vertical (Line)	Horizontal frequency (kHz)	Vertical frequency (Hz)	Standard
VGA	640	480	31.5	60	VGA
SVGA	800	600	37.9	60	VESA Guidelines
XGA	1024	768	48.4	60	VESA Guidelines
WXGA	1280	768	47.4	60	VESA
WXGA	1280	768	47.8	60	VESA
WXGA	1360	768	47.7	60	VESA
SXGA	1280	1024	64	60	VESA
UXGA	1600	1200	75	60	VESA
HDTV	1920	1080	67.5	60	EIA

- This TV's PC input does not support Sync on Green or Composite Sync.
- This TV's PC input does not support interlaced signals.
- This TV's PC input supports signals in the above chart with a 60 Hz vertical frequency.

PC Input Signal Reference Chart for HDMI IN 1, 2, 3 and 4

Signals	Horizontal (Pixel)	Vertical (Line)	Horizontal frequency (kHz)	Vertical frequency (Hz)	Standard
VGA	640	480	31.5	60	VGA
SVGA	800	600	37.9	60	VESA Guidelines
XGA	1024	768	48.4	60	VESA Guidelines
WXGA	1280	768	47.4	60	VESA
WXGA	1280	768	47.8	60	VESA
WXGA	1360	768	47.7	60	VESA
SXGA	1280	1024	64	60	VESA

Troubleshooting

Check whether the  (standby) indicator is flashing in red.

When it is flashing

The self-diagnosis function is activated. Press  on the side of the TV to turn it off, disconnect the mains lead, and inform your dealer or Sony service centre.

If the red LED flashes 19 times, please switch off the set and remove the faulty USB device.

If the red LED flashes 20 times, please switch off the set and remove the faulty CAM device.

When it is not flashing



- 1 Check the items in the tables below.
- 2 If the problem still persists, have your TV serviced by qualified service personnel.



- You can refer to the complete troubleshooting section in the on-screen instruction manual.
- For further information, please contact Sony Customer Information Centre at the address or telephone that appears on the supplied guarantee.

Picture

No picture (screen is dark) and no sound

- Check the aerial/cable connection.
- Connect the TV to the mains, and press  on the side of the TV.
- If the  (standby) indicator lights up in red, press .

No picture or no menu information from equipment connected to the scart connector

- Press  to display the connected equipment list, then select the desired input.
- Check the connection between the optional equipment and the TV.

Double images or ghosting

- Check the aerial/cable connection.
- Check the aerial location and direction.

Only snow and noise appear on the screen

- Check if the aerial is broken or bent.
- Check if the aerial has reached the end of its serviceable life (three to five years in normal use, one to two years at the seaside).

Picture or sound noise when viewing a TV channel

- Adjust “AFT” (Automatic Fine Tuning) to obtain better picture reception (page 29).

Some tiny black points and/or bright points appear on the screen

- The picture of a display unit is composed of pixels. Tiny black points and/or bright points (pixels) on the screen do not indicate a malfunction.

No colour on programmes



- Select “Reset” (page 25).

No colour or irregular colour when viewing a signal from the COMPONENT IN sockets

- Check the connection of the  COMPONENT IN sockets and check if each socket is firmly seated in their respective sockets.

Sound

No sound, but good picture

- Press  + or  (Mute).
- Check if the “Speaker” is set to “TV Speaker” (page 26).
- When using HDMI input with Super Audio CD or DVD-Audio, DIGITAL AUDIO OUT (OPTICAL) may not output audio signals.

Channels

The desired channel cannot be selected

- Switch between digital and analogue mode and select the desired digital/analogue channel.

Some channels are blank

- Scrambled/Subscription only channel. Subscribe to the pay TV service.
- Channel is used only for data (no picture or sound).
- Contact the broadcaster for transmission details.

Digital channels are not displayed

- Contact a local installer to find out if digital transmissions are provided in your area.
- Upgrade to a higher gain aerial.

General

The TV turns off automatically (the TV enters standby mode)

- Check if the “Sleep Timer” (page 26) or “Idle TV Standby” (page 26) is activated.
- If no signal is received and no operation is performed in the TV mode for 15 minutes, the TV automatically switches to standby mode.

Distorted picture and/or sound

- Keep the TV away from electrical noise sources such as cars, motorcycles, hair-dryers or optical equipment.
- When installing optional equipment, leave some space between the optional equipment and the TV.
- Check the aerial/cable connection.
- Keep the aerial/cable TV cable away from other connecting cables.

The remote does not function

- Replace the batteries.

HDMI equipment does not appear on “HDMI Device List”

- Check that your equipment is compatible with control for HDMI.

If “Store Display Mode: On” is displayed on the screen

- Your TV is set to “Shop” mode. You need to set “Home” for “Location” in the “Auto Start-up” procedure again (page 7).

Not all channels are tuned

- Check support web site for cable provide information. <http://support.sony-europe.com/TV/DVBC>